

Quick Start Guide



Access Point
ion4xe/ion4xe_ext

ANYWHERE
EVERYWHERE



Introduction

Thank you for purchasing our ion4xe/ion4xe_ext, a cutting-edge centrally managed Access Point. This device is Wi-Fi 6 certified, featuring a 2x2:2 MU-MIMO setup that sets new standards for wireless performance and efficiency.

Packaging Content



ion4xe/ion4xe_ext
Access Point (Qty:1)

SFP Gland (1)

RJ45 Gland (1)



Pole Mounting Kit
Pole Clamp (1), L Plate (1), U Bolt (1),
SEMs Screws (4), Hex Nuts (4)

Product Specifications

Peak Data Rate (aggregate)	Up to 1.78 Gbps (1202 Mbps for 5 GHz and 574 Mbps for 2.4 GHz)
Wi-Fi Standard Support	802.11a/b/g/n/ac/ac Wave 2/ax
Interface	1 X 10/100/1000 BASE-T Ethernet 1 X 2500 Base X Optical Ethernet SFP
Radio Mode	2x2 MU-MIMO with 2 spatial streams
Mesh Support	Self-creating, Self-healing EasyMesh
Maximum number of SSID (per radio)	16
Maximum User Support	1024 clients per Access Point (512 clients per radio)
Power Supply	IEEE 802.3at PoE/PoE+
Power Consumption (Max)	17 W (approx.)
Max Transmit Power	30 dBm for 2.4 GHz, 30 dBm for 5 GHz (will depend on country-specific guidelines)
Antenna Type	Option for external antenna
Management	Standalone (via GUI) or through on-premise based solution or cloud-based
Enclosure Dimensions	182 x 185 x 89 mm or 7.17 x 7.28 x 3.5 inches
Weight	1 kg
Operating Temperature	-15°C to 60°C (ion4xe) -40°C to 60°C (ion4xe_ext)
Certifications	FCC Class A, CE, Passpoint 2.0, WPA3, EasyMesh RoHS 3.0
Variants	ion4xe - N-connectors; Normal temperature operation ion4xe_ext - N-connectors; Extended temperature operation

Product Overview

SFP Port
(Connects fiber cable
with maximum data
transfer rate
capability of 2.5 Gbps)

N Type connectors

LED



LAN + PoE Port
(Power up the device
using PoE Adaptor and a
regular Ethernet Cable)

Earthing Point

Mounting of Access Point

The Access Point can be mounted on a pole or onto a wall. Perform the following steps for appropriate installation.

1. Align L Plate with the holes at the back of Access Point
2. Use the provided SEMS Screws to fix the plate onto the Access Point



The L Plate mounting bracket is fixed onto the mounting holes on the Access Point

Pole Mount

- ⋮⋮⋮ **1.** Align the bracket mounted Access Point with Pole Clamp & U-Bolt
- ⋮⋮⋮ **2.** Pass the U-Bolt through the cuts of Pole Clamp & L Plate. Secure it in place with the Hex Nuts.



- ⋮⋮⋮ **3.** Access Point has the freedom of movement along with the vertical & horizontal axis



Note: The pole mounting is designed for poles of diameter 40 mm to 60 mm. For mountings on larger size poles upto 140 mm, contact at iosales@hfcl.com

Wall Mount

To mount the Access Point on a wall, use the wall mounting bracket, drywall screws, and screw anchors (* The entire wall mounting assembly is sold separately)

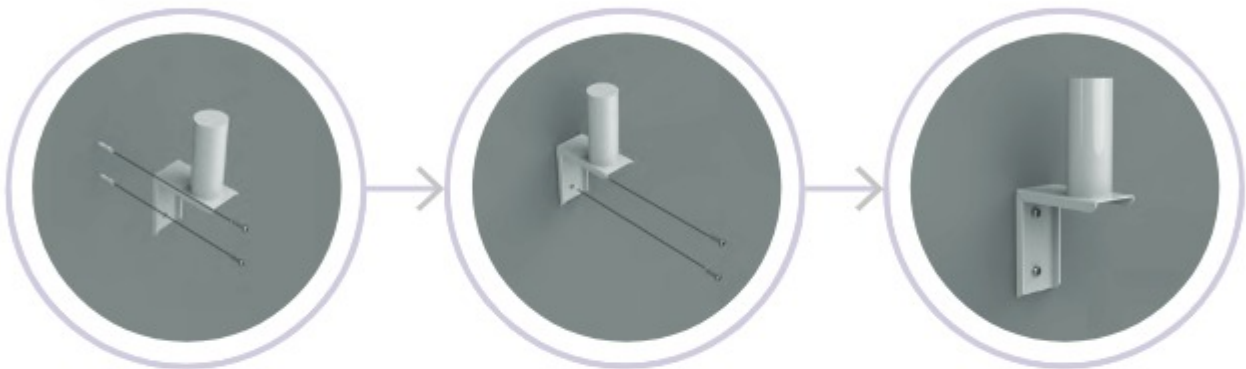

1. Take the reference from the wall mounting bracket and mark the position of the holes on the wall
2. Use the drill machine to drill 2 holes on respective marked positions
3. Push the screw anchors into the holes with a hammer
4. Align the drilled holes with the holes of wall mounting bracket
5. Insert the drywall screws through the holes of mounting bracket into the wall
6. Wall mounting bracket is fixed to the wall
7. Mount the device onto the wall mounting bracket as discussed in pole mounting process.

Attaching External Antennas

:::: Sector Antenna ::::

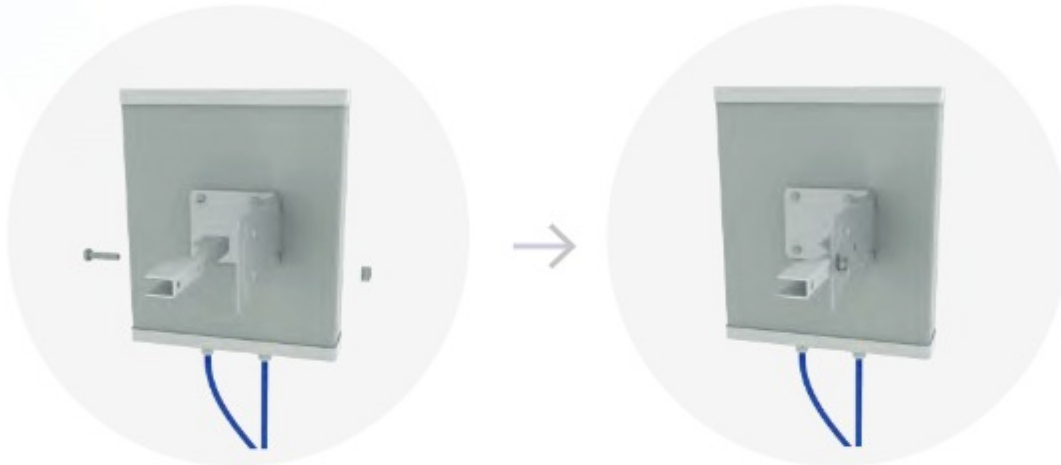

:::: 1. Secure the mounting bracket on the back of the sector antenna using provided fasteners.

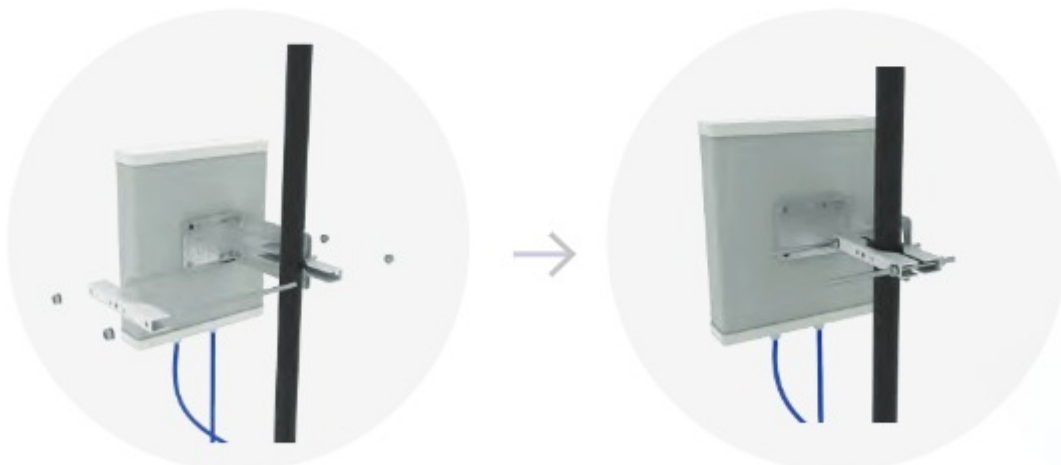

:::: 2. Align the bracket mounted sector antenna with the pole clamp

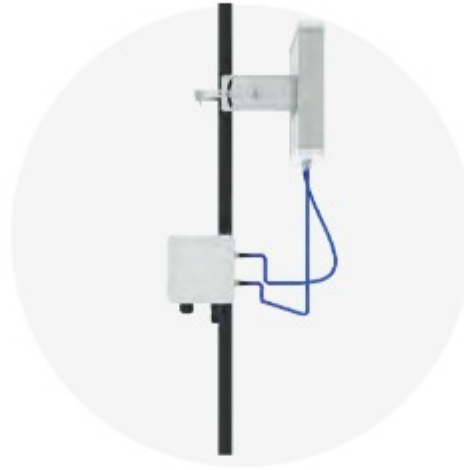

- ⋮⋮⋮ **3.** This type of mounting enables vertical and horizontal movement by loosening few of the bolts as shown above.

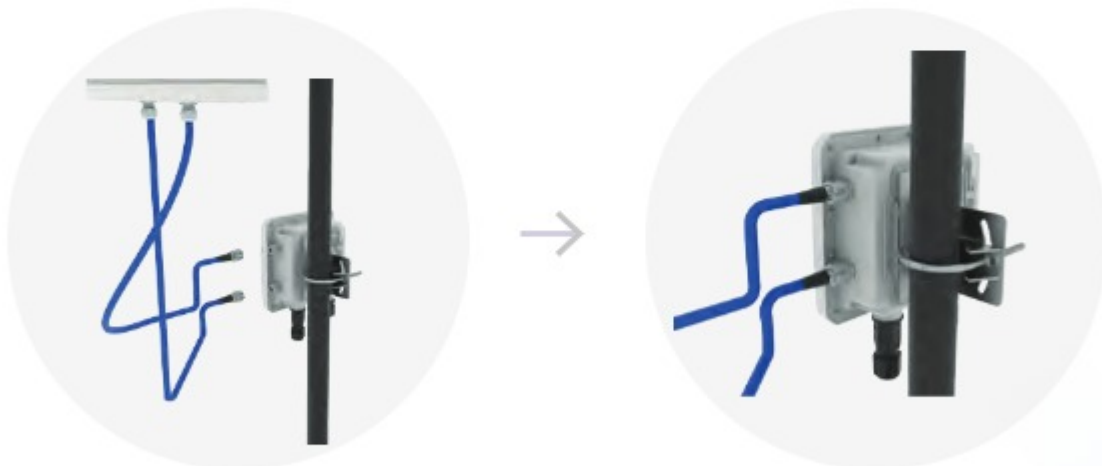

- ⋮⋮⋮ **4.** Attach one end of the RF Cables to the sector antenna & the other end on the N type connectors of the Access Point



⋮⋮⋮ **5.** The final view is as shown above.

WARNING:

HFCL cannot be held liable for any damages incurred during the process

Omni Antenna

Attach omnidirectional antenna on the N Type Connectors of the Access Point



Getting the Access Point Online



Step 1:

Power up the device and connect to the network

Follow the steps mentioned below and connect the Access Point to a network:

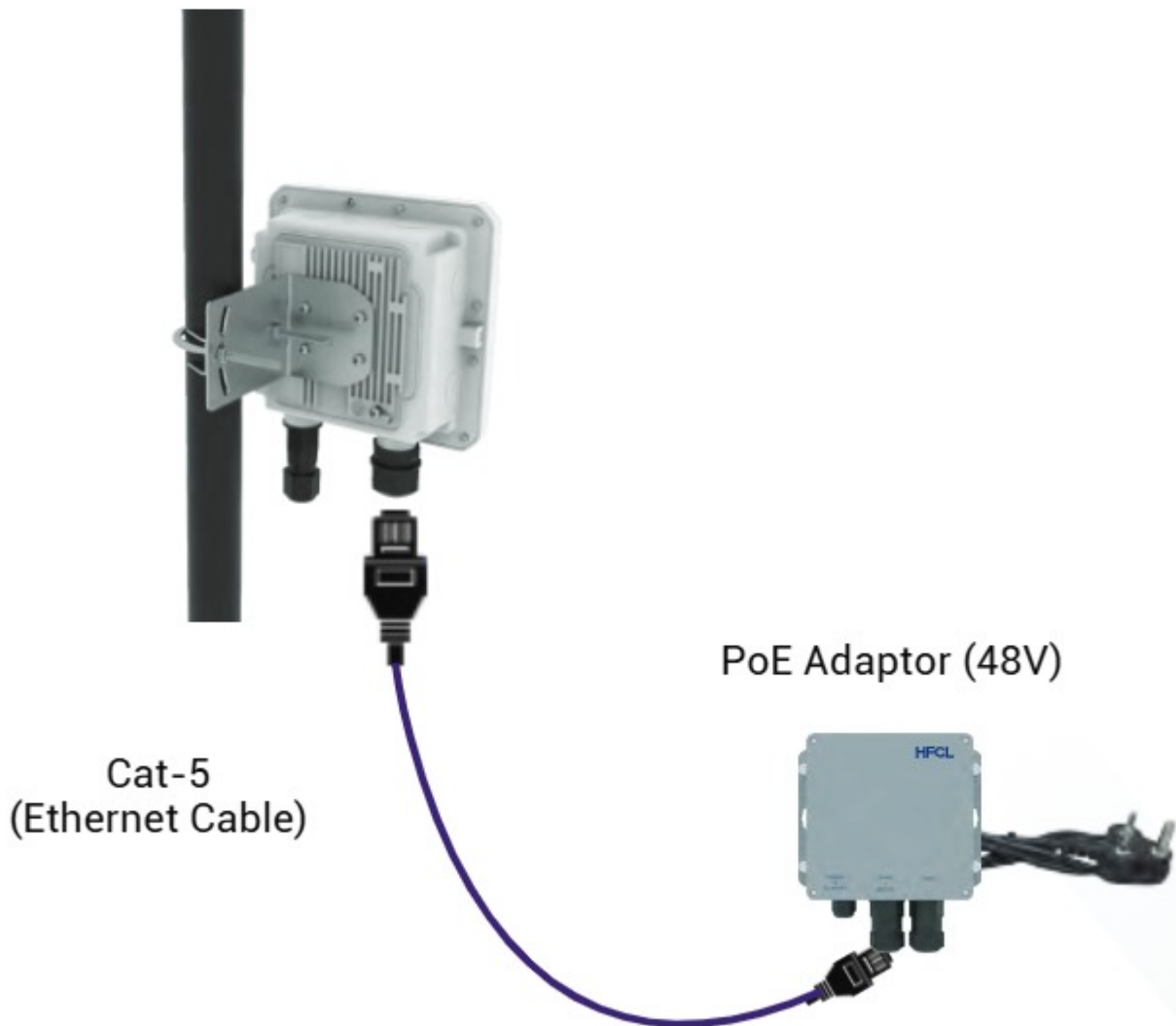

Note: Plug and Adaptor will vary by country/region

Power up using PoE Adaptor

:::: **Section 1:** Standalone AP ::::

- :::: **1.** Connect an Ethernet cable to the computer
- :::: **2.** Connect the other end of Ethernet cable to the data port on PoE adaptor
- :::: **3.** Connect Access point PoE supported Ethernet port to PoE adaptor power port. Device will be powered on

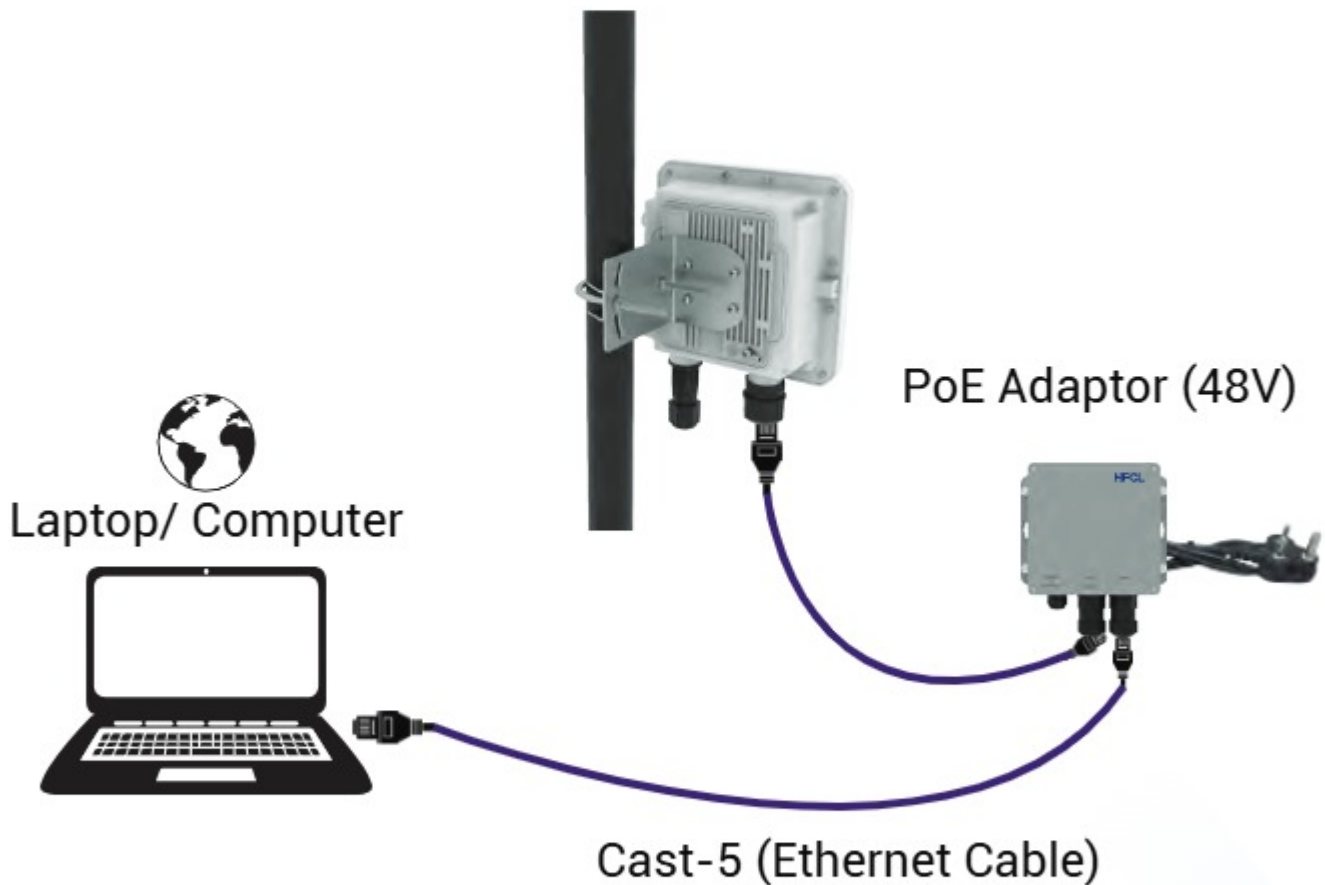

- :::: **4.** Configure the computer with a same domain static IP 192.168.1.X and a subnet mask of 255.255.255.0 (X is from 2 to 255)
- :::: **5.** Open the web browser and enter the Access Point static IP address in the address bar: 192.168.1.1

- :::: 6. A login screen will appear
- :::: 7. Enter the default login credential details:
User-root, Password-hfcl!@ion

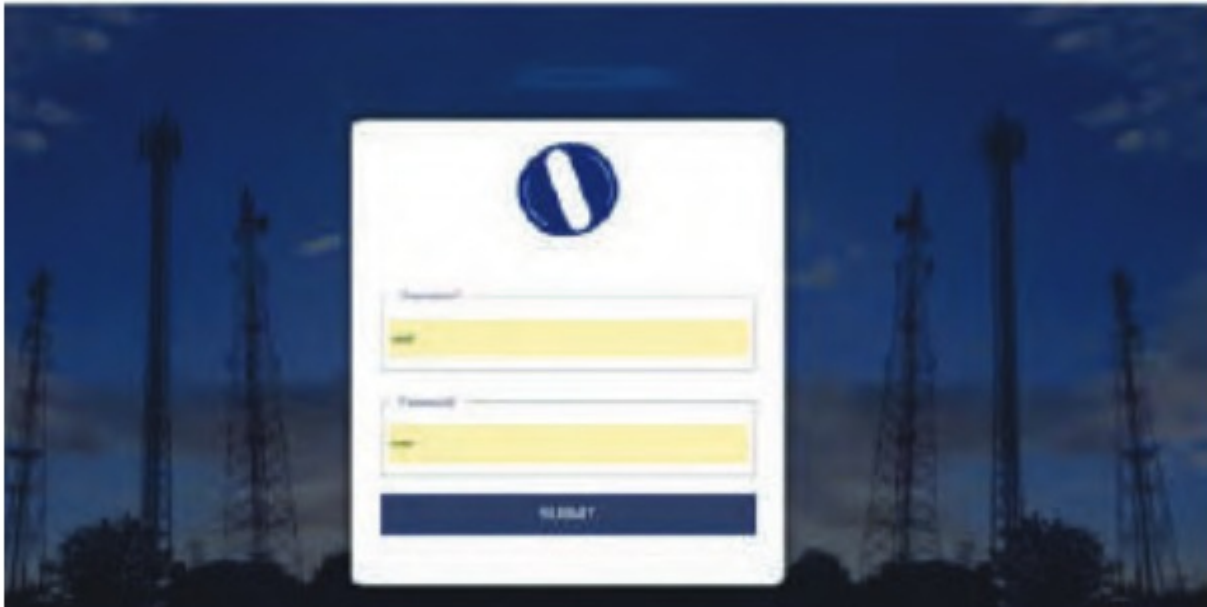

:::: **Section 2:** Controller Managed AP ::::

Follow the steps mentioned to connect Access Point to a network:

- :::: 1. Power-up the AP through PoE adaptor or PoE switch
- :::: 2. Connect the AP to DHCP network and Internet
- :::: 3. Login to HFCL io cloud controller (cNMS) iocloud.hfcl.com with credentials provided
- :::: 3a. To get cNMS login credential, please send a request to iosupport@hfcl.com with below details

Customer name	Customer email address	Customer address	Customer contact number	Distributor/ Retailer Name	No. of AP Purchased	Country

- :::: 4. Add AP group under configuration
- :::: 5. Add APs in the AP group
- :::: 6. Create SSID in the AP group
- :::: 7. Refer our website io.hfcl.com for detailed information to configure AP through cNMS

Step 2:

Check the LED status

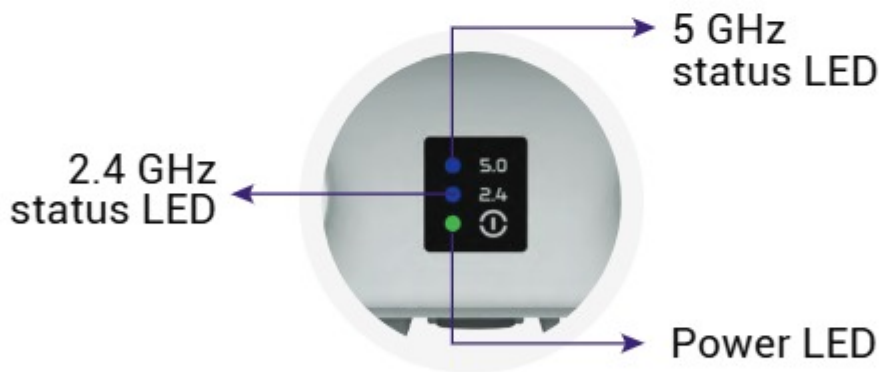



LED COLOR	STATUS
Power LED	Green color notifies the user that the device is powered ON
2.4 GHz Status LED	Solid blue color notifies the user that the 2.4 GHz radio is active and blinks while data is being transmitted on 2.4 GHz radio
5 GHz Status LED	Solid blue color notifies the user that the 5 GHz radio is active and blinks while data is being transmitted on 5 GHz radio

Safety Precautions





Observe the following safety precautions to avoid damage to the Access Point:

-  Do not power the device during installation

-  Keep away from high voltage cables

-  Do not power off the unit in the middle of an upgrade process

-  The glands should be ground facing all the time

-  Do not open the enclosure

-  Fasten the device tightly

-  Make sure the earthing wire is connected properly to the earthing point

Part Number: QSG-01-0010
Revision: B



Suite 2101, Bahrain Financial Tower (West Tower)
P.O. Box 2591, Kingdom of Bahrain

☎ 17565171 📱 17565171 ✉ enquiries@northstar-telecom.net

www.northstar-telecom.net

HFCL Limited All Rights Reserved. HFCL and io by HFCL are trademarks or registered trademarks of HFCL Ltd. Specifications are subject to change without notice.